

OWNER'S MANUAL —
Please read before using this equipment.

21-1711

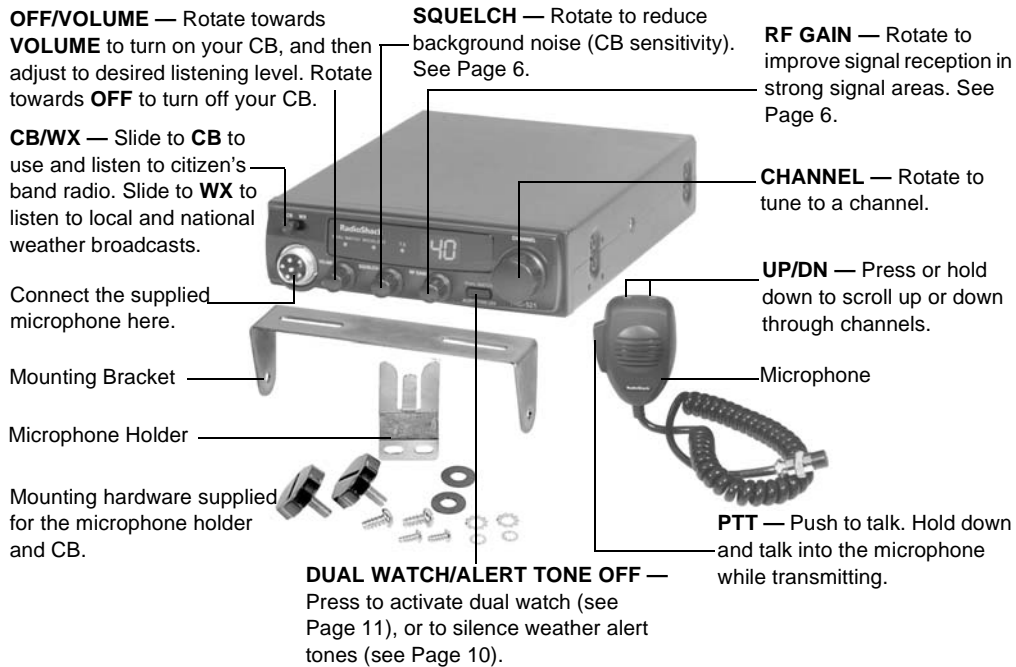

Thank you for purchasing the RadioShack TRC521 CB Radio. It provides two-way communication on the citizen's radio band and lets you tune to local and national weather service broadcasts. It provides the maximum legal power output for the greatest available range, and a built-in PLL (phase-locked loop) frequency synthesizer to reduce congestion.

CB radio provides hours of fun and entertainment! Listen and talk to people from all over the country while traveling, and make new friends along routes that you regularly travel. It is also a great way to keep informed of local emergencies, such as traffic accidents, road blocks, weather alerts and so on.

! IMPORTANT !

If an icon appears at the end of a paragraph, go to the box on that page with the corresponding icon for pertinent information.

⚠ — Warning

☠ — Caution

📌 — Note

© 2004 RadioShack Corporation.
All Rights Reserved.
RadioShack and RadioShack.com
are trademarks used by
RadioShack Corporation.

CONTENTS

CB Radio Setup	2
Attach the Microphone Holder	2
Mount the CB	2
Connect the Microphone	3
Connecting an Antenna	3
Connecting to Vehicle	3
Battery Power	4
Connecting an Optional External Speaker	4
Using the CB as a Base Station ..	5
Receiving and Transmitting	6
Receiving	6
Transmitting	6
Using Common 10-Codes	7
Tips for Using Your CB	8
Business Use	8
Personal Use	8
Transmission Courtesy	8
Maximum Range	9
Reducing Noise	9
Listening to the Weather Band ..	10
Using Digital Weather Alert ...	10
Using Dual Watch	11
Replacing the Fuse	11
Troubleshooting	12
Care	12
Service and Repair	12
FCC Information	13
Specifications	14
Accessories	15

⚠ WARNING ⚠

Mount the CB securely to avoid damage to the CB or vehicle, and to avoid injury to anyone in the vehicle during sudden starts or stops.

CB RADIO SETUP

Your CB's display is protected during shipment by a piece of clear film. Carefully peel off this film before using your radio.

ATTACH THE MICROPHONE HOLDER

You can attach the microphone holder horizontally or vertically to either side of your CB.

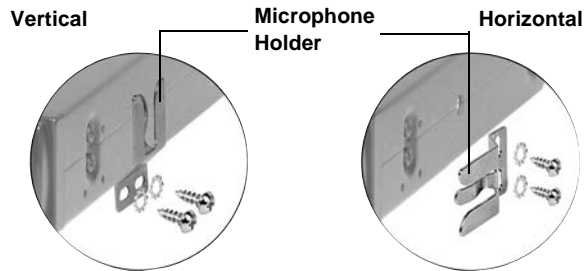

To attach the microphone holder somewhere else, follow these steps.

1. Use the microphone holder as a template to mark the positions for the mounting screws at the desired mounting location.
2. Drill a hole at the marked position. Do not drill into anything behind the mounting surface.
3. Attach the microphone holder to the mounting surface using the supplied (small) machine screws and lockwashers.

MOUNT THE CB

Find a convenient location in your vehicle to mount your CB. If you are uncomfortable mounting the CB yourself, consult with your vehicle service center or automotive dealer for assistance. ⚠

Select a mounting location where:

- you can easily reach the CB.
- wires and cables are clear of the vehicle's pedals or other moving parts.
- the CB is not directly in front of heating vents.
- all wires and cables can reach their connection points.

1. Use the mounting bracket as a template to mark the positions for the screws on the mounting surface.

2. At the marked positions, drill a hole slightly smaller than the mounting screws. Do not drill into objects behind the mounting surface.
3. Secure the mounting bracket to the mounting surface with the supplied screws and lockwashers.

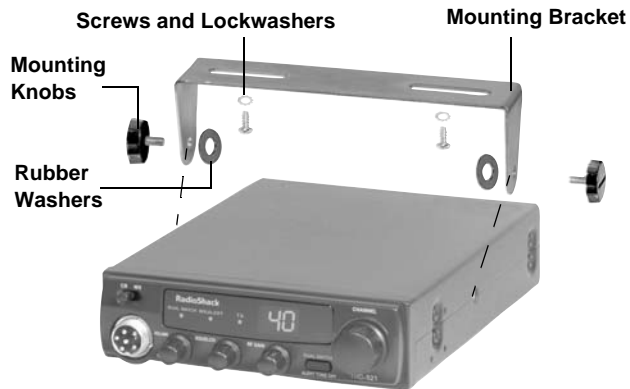

4. Attach the CB to the mounting bracket with the supplied rubber washers and mounting knobs.

CONNECT THE MICROPHONE

1. Align the holes inside the microphone's plug with the pins in the microphone jack and insert the plug.
2. Turn the plug's locking nut clockwise to secure it.
3. Slide the microphone onto the holder.
4. To disconnect the microphone, unscrew the locking nut and pull the microphone plug toward you. Do not pull the microphone cable.



CONNECTING AN ANTENNA

To use this CB, you need a mobile or base station antenna. There are many types of antennas for CBs. Each type has its own benefits, so choose the one that best meets your needs. Your local RadioShack store sells a wide variety of antennas. If you are using this CB as a base station, see "Using the CB as a Base Station" on Page 5.

Dual band antennas provide optimum reception of CB and WX channels. For mobile installations (car, boat), a non-directional antenna provides the best CB reception. Mobile antennas use your vehicle's metal body as a ground plane. If the CB is installed in a boat, your boat's steel hull is used as a ground plane. Without a steel hull serving as a ground plane, you will not receive maximum efficiency. Before using your CB in a boat, consult with your boat dealer regarding an adequate grounding system.

Keep in mind that for the best performance you should mount the antenna:

- as high as possible.
- as far as possible from sources of electrical noise.
- vertically.

1. Follow the antenna's instructions to mount it.

2. Route the antenna cable to the CB radio and connect it to the **ANT.** jack. 

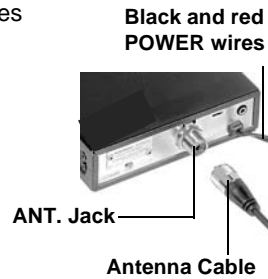

CAUTION

- Avoid routing the cable next to sharp edges or moving parts, which might damage the cable.
- Do not run the cable next to power cables or other radio antenna cables.
- Do not run the cable through the engine compartment or other areas that produce extreme heat.

NOTE

Do not connect the black wire to a non-metallic (plastic) part, or to any part insulated from the vehicle's chassis by a non-metallic part.

CONNECTING TO VEHICLE BATTERY POWER

1. Connect the CB's red **POWER** wire to a terminal in your vehicle's fuse box that has power only when the ignition is in the ACC (accessory) or ON position.
2. Connect the CB's black **POWER** wire to a metal part of the vehicle's frame (chassis ground). 

CONNECTING AN OPTIONAL EXTERNAL SPEAKER

You can connect an external speaker to the CB. Use an 8-ohm speaker with a 1/8-inch (3.5-mm) plug. Insert the speaker's plug into the CB's **EXT. SP.** jack.

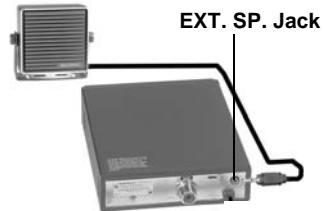

USING THE CB AS A BASE STATION

Although this CB is designed for mobile use, you can use it as a base station with an AC power source. Your local RadioShack store carries a wide selection of base station antennas, coaxial antenna cable, connectors, and base station power supplies. For base station installation, you need the following items:

- a 12-volt DC power supply that can supply at least 1.5 amps. ⚡
- base station antenna.
- coaxial antenna cable and connectors.

1. Mount the base station antenna as described in its owner's manual. ⚠
2. Connect the antenna cable to the **ANT.** jack on the back of the CB.
3. Connect the CB's black **POWER** wire to the negative (–) terminal on the DC power supply.

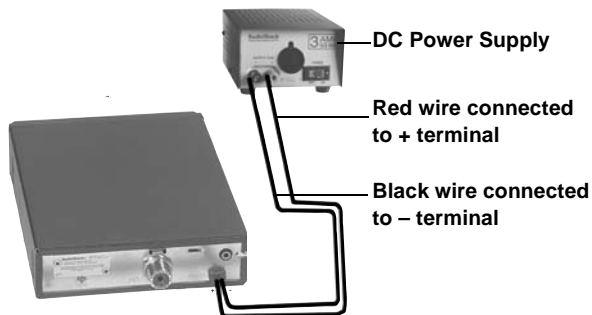
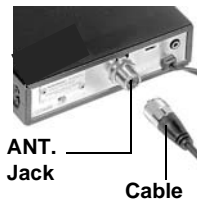

4. Connect the CB's red **POWER** wire to the positive (+) terminal on the DC power supply.
5. Connect the DC power supply to a standard AC outlet.

⚡ CAUTION ⚡

Most 12-volt DC power supplies plug into a standard AC outlet to produce DC power. Before connecting your CB to a 12-volt DC power supply, read and follow the instructions included with the power supply.

⚠ WARNING ⚠

Use extreme caution when you install or remove a base station CB antenna. If the antenna starts to fall, let it go. It could contact overhead power lines. If the antenna touches a power line, contact with the antenna, mast, cable, or guy wires can cause electrocution and death. Call the power company to remove the antenna. **DO NOT** attempt to do so yourself.

RECEIVING AND TRANSMITTING

We recommend you try receiving transmissions before you transmit.

RECEIVING

1. Rotate **OFF/VOLUME** towards **OFF** until it clicks to turn off the CB.
2. Slide **CB/WX** to **CB**.
3. Rotate **SQUELCH** fully counterclockwise.
4. Rotate **RF GAIN** fully clockwise.
5. Rotate **OFF/VOLUME** clockwise to turn on the CB. The display lights and the channel number appears. An alert sounds if a weather alert signal is detected (see "Using Digital Weather Alert" on Page 10).
6. To decrease CB sensitivity so you do not hear weak, distant signals, slowly rotate **SQUELCH** clockwise until the hissing stops. To increase sensitivity and to receive very weak signals, rotate **SQUELCH** counterclockwise. ↙
7. Rotate **RF GAIN** clockwise to optimize reception (incoming signal strength). Or, rotate it counterclockwise to decrease signal strength. ↘
8. To tune to a channel, rotate **CHANNEL** on the radio, or press **UP** or **DN** on the microphone. To quickly scroll through channels in either direction, hold down **UP** or **DN** until you reach the desired channel.
9. Adjust **VOLUME** to a comfortable listening level.
10. To turn off the CB, rotate **OFF/VOLUME** counterclockwise to **OFF** until it clicks.

NOTE

- Only rotate **SQUELCH** until the hissing stops. If you continue to rotate it clockwise, you will be unable to receive any signals.
- You may want to purchase an SWR (Standard Wave Ratio) meter to measure your range and signal strength. This will enable you to adjust your antenna for maximum range, and determine the best position for **RF GAIN**. See your SWR meter owner's manual for instruction on how to use it.

TRANSMITTING

1. To transmit, hold down **PTT** on the microphone. Hold the microphone about 2–3 inches from your mouth and speak in a normal tone of voice. **TX** lights to indicate transmission.
2. When you finish transmitting, release **PTT**. **TX** turns off.

- To turn off the CB, turn **OFF/VOLUME** counterclockwise to **OFF** until it clicks.

USING COMMON 10-CODES

Citizen's Band operators have adopted 10-codes for standard questions and answers. These codes permit faster communication and better intelligibility in noisy areas. The more popular codes follow:

Code	Meaning
10-1	Receiving poorly.
10-2	Receiving well.
10-3	Stop transmitting.
10-4	OK, message received.
10-5	Relay message.
10-6	Busy, please stand by.
10-7	Out of service.
10-8	In service
10-9	Repeat message.
10-10	Transmission completed, standing by.
10-11	Talking too rapidly.
10-12	Visitors present.
10-13	Advise Weather/Road conditions.
10-17	Urgent business.
10-18	Anything for us?
10-19	Nothing for you. Return to base.
10-20	My location is_____.
10-21	Call by telephone.
10-22	Report in person to_____.
10-23	Please stand by.
10-25	Can you contact_____.
10-26	Disregard last information.
10-27	I am moving to channel_____.
10-28	Identify your station.
10-32	I will give you a radio check.
10-33	Emergency traffic.
10-36	Correct time is_____.
10-37	Wrecker needed at_____.
10-38	Ambulance needed at_____.
10-41	Please turn to channel_____.
10-42	Traffic accident at_____.
10-43	Traffic tie-up at_____.
10-50	Break channel.
10-62	Unable to copy; use telephone.
10-70	Fire at_____.

This table lists the code meanings in the form of a statement. They can also be phrased as questions. For example, “10-6: Are you busy?”, “10-20: What is your location?”.

TIPS FOR USING YOUR CB

Like most activities, CB radio has its customs and courtesies. The following tips will help you get the most enjoyment from your CB.

BUSINESS USE

- Truck drivers and delivery personnel can learn road and traffic conditions and get assistance in locating destinations. A CB is also good company on long road trips.
- On construction crews, a CB quickly pays for itself when you are calling for additional materials or coordinating the activities of different work crews.
- For security officers, a CB is more than a convenience — it is a must for both safety and efficiency.

PERSONAL USE

- Keep in touch with home while driving to work, to the store, or to a social activity. Let your family know you are tied up in traffic or that you will stop by the store on the way home.
- If you are a two-car (or more) family, CBs are great for communicating with family members while they are in their cars.
- Contact friends or neighbors. Find out “what’s happening” or plan a get-together.
- Ever have car trouble or run out of gas on the highway? What an assurance it is to be able to call for assistance!
- Camping, fishing, and other sports are more fun with a CB. Locate a buddy or find out “what’s cooking” back at camp.

TRANSMISSION COURTESY

- Wait for a pause in someone else’s transmission before you ask for a break.
- If you do not receive an answer to your call after a second attempt, sign off and wait several minutes before trying again.

- Do not hold down **PTT** when you are not talking. (This is called dead keying.)
- Assist callers with directions, information about road conditions, and any other reasonable requests.

MAXIMUM RANGE

Your CB radio's transmission range is generally line-of-sight. The maximum range and quality of CB transmissions vary depending on the following conditions:

- the type and quality of antenna used.
- the height of the antenna's mounting location — the higher the antenna, the better the signal's range.
- the surrounding terrain — mountains and tall buildings limit the range.
- weather conditions.
- the number of nearby CBs operating on the same channel.
- standing wave ratio (SWR) between the antenna and the CB.

REDUCING NOISE

Because your CB is exceptionally quiet, any noise you hear is probably from an external source in your vehicle, such as the alternator, another radio, or spark plugs. You can determine the noise source by turning off the engine and operating the CB with your vehicle's ignition set to ACC. If the noise is reduced, the problem is in your vehicle's ignition or electrical system.

To reduce or eliminate such noise:

- Make all CB power and antenna wires as short as possible.
- Keep the power wires away from the antenna wires.
- Be sure the chassis ground connection is secure.
- Replace old ignition wires with new, high-voltage, noise-suppression wires.
- Install noise suppressors on your spark plugs, or install new spark plugs that have built-in noise suppressors.
- If problems persist, check your alternator/generator and regulator gauges. You can reduce the noise from these sources by using bypass capacitors at the various output voltage points.

LISTENING TO THE WEATHER BAND

The National Oceanic and Atmospheric Administration (NOAA) broadcasts local forecast and regional weather information on one or more of seven channels in the US. We have pre-programmed your CB with all seven of these frequencies.

Channel	Frequency (MHz)
WX1	162.400
WX2	162.425
WX3	162.450
WX4	162.475
WX5	162.500
WX6	162.525
WX7	162.550

To listen to a weather broadcast or alert, slide **CB/WX** to **WX**. Rotate **CHANNEL** to select a frequency. ☑

To verify reception, your radio must receive a test or emergency alert broadcast. The National Weather Service broadcasts a test alert every week. To find the specific test schedule in your area, contact your local NOAA or National Weather Service office.

USING DIGITAL WEATHER ALERT

When in CB mode, the radio automatically sounds an alert if a weather alert signal is detected. This is especially useful when your area is expecting severe weather conditions.

When your local weather station broadcasts a severe weather alert, the CB sounds a tone corresponding to the alert type and **WX/ALERT** lights.

Alert Type	You Hear
Warning	Continuous short beeps
Watch	Three short beeps and a 2 second pause (repeats)
Advisory	Two short beeps and a 2 second pause (repeats)
Test	One short beep and a 3 second pause (repeats)
EAT (Emergency Action Termination)	One short beep and a 3 second pause (repeats) ☑

☑ NOTE ☑

- **PTT** does not work when **CB/WX** is set to **WX**. You can only send transmissions when in CB mode.
- You cannot transmit while **WX/ALERT** flashes in CB mode.
- The alert tones for a Test and EAT (Emergency Action Termination) sound very similar. We suggest you switch to WX mode immediately to listen to the weather broadcast.
- Because of atmospheric conditions, you may receive signals that do not contain information relevant to the emergency level. This is normal.
- The radio sounds an alert regardless of the channel setting.
- The CB will not sound an alert while you are transmitting.
- If you are in a rural or fringe area, your radio might be triggered by an alert broadcast in one area, but not be triggered if you travel to another area (even close by).

To silence the alert tones, press **ALERT TONE OFF**. **WX/ALERT** flashes until you switch to **WX** mode and listen to the broadcast. Or press **PTT** to silence the alert tones so **WX/ALERT** stops flashing. 

To reduce the alert tone levels for subsequent alerts, hold down **ALERT TONE OFF** for about two seconds while **WX/ALERT** flashes. The tone stops and **WX/ALERT** flashes slowly. If the radio receives a new weather alert, three low-level, short beeps sound (regardless of alert type).

To listen to the weather when an alert is received, slide **CB/WX** to **WX**. **WX/ALERT** turns off.

USING DUAL WATCH

You can set your radio to constantly monitor for emergency (Channel 9) signals. If an emergency signal is received, the CB radio automatically tunes to Channel 9 so you can hear the broadcast. When finished, the radio returns to the previous station. This feature only works in CB mode.

To activate dual watch, press **DUAL WATCH**. **DUAL WATCH** lights. Press **DUAL WATCH** again to deactivate.

REPLACING THE FUSE

The CB's in-line fuse protects it from power surges and short circuits. When replacement is required, use a 2-amp, fast-acting glass fuse, available at your local RadioShack store.

1. Make sure the vehicle and CB are turned off.
2. Hold the fuse holder at both ends, push the ends together, twist one end counterclockwise, and pull them apart.

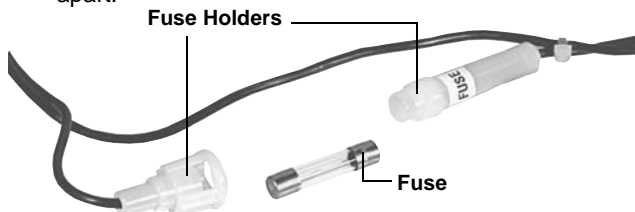

3. Remove the old fuse and inspect its condition. If it is blown, insert a new one of the same type and rating. If it is not blown, reinsert it. 
4. Push the fuse holder ends together and twist one end clockwise.

NOTE

You cannot transmit while **WX/ALERT** flashes in CB mode.

CAUTION

Do not use a fuse with ratings other than those specified here. Doing so will make your CB susceptible to electrical damage.

TROUBLESHOOTING

We do not expect you to have any problems with your CB, but if you do, the following suggestions might help.

Symptom	Suggestion
Trouble receiving.	Make sure POWER is on. Make sure SQUELCH is adjusted properly. Be sure RF GAIN is fully clockwise. Make sure the CB is set to an operating channel. Make sure the microphone is securely connected. Check for a good antenna connection.
Trouble transmitting.	Make sure the antenna cable is securely connected to the radio. Make sure the antenna is fully extended. Make sure all connections are secure and free of corrosion. Make sure CB/WX is set to CB .
The CB is completely inoperable.	Check the DC power cord and in-line fuse. Replace the fuse. See "Replacing the Fuse" on Page 11.

If these tips do not solve the problem, do not attempt repairs or adjustments yourself. The CB should be serviced only by a qualified radio technician. If you still have problems, take your CB to your local RadioShack store for assistance.

CARE

Keep the CB dry; if it gets wet, wipe it dry immediately. Use and store the CB only in room temperature environments. If used in a boat, do not expose CB to extreme heat or cold for prolonged periods of time. Handle the CB carefully; do not drop it. Keep the CB away from dust and dirt, and wipe it with a damp cloth occasionally to keep it looking new.

SERVICE AND REPAIR

If your CB is not performing as it should, take it to your local RadioShack store for assistance. To locate your nearest RadioShack, use the store locator feature on RadioShack's website (www.radioshack.com), or call 1-800-The Shack (843-7422) and follow the menu options. Modifying or tampering with the CB's internal components can cause a malfunction and might invalidate its warranty and void your FCC authorization to operate it.

FCC INFORMATION

The Federal Communications Commission (FCC) does not require you to have a license to operate this CB. However, the FCC does require that you read and know Part 95 of FCC Rules. These rules apply to the operation of a Class D CB.

Warning: Do not open your CB to make any internal adjustments. Any internal adjustments can be made only by an authorized service technician.

Unauthorized internal adjustments and/or modifications can lead to illegal operation as defined by Part 95 of FCC Rules. Such illegal operation can lead to very serious consequences.

Your CB might cause TV or radio interference even when it is operating properly. To determine whether your CB is causing the interference, turn off your CB. If the interference goes away, your CB is causing it. Try to eliminate the interference by:

- moving your CB away from the receiver
- connecting your CB to an outlet that is on a different electrical circuit from the receiver
- contacting your local RadioShack store for help

If you cannot eliminate the interference, the FCC requires that you stop using your CB.

This device complies with Part 15 of the FCC Rules. Operation is subject to the following two conditions: (1) this device may not cause harmful interference, and (2) this device must accept any interference received, including interference that may cause undesired operation.

SPECIFICATIONS

RECEIVER

Frequency Response (1 kHz, 0 dB Reference)	
Lower, at 450 Hz	-3 dB
Upper, at 2500 Hz	-3 dB
Intermediate Frequency	
First IF	10.695 MHz
Second IF	455 kHz
Maximum Sensitivity	1 μ V
Sensitivity for 10 dB S/N	1 μ V or better
AGC Figure of Merit	
50 mV for 10 dB Change in Audio Output	90 dB
Overload AGC Characteristics (from 50 mV to 1000 mV)	4 dB
Adjacent Channel Selectivity	55 dB
Image Rejection	Typically better than 60 dB
IF Rejection	65 dB or better
Maximum Audio Output Power	4 Watts at 8 ohms
Squelch Range	Adjustable from 0.5 μ V to 1 mV
Receive Battery Drain	280 mA to 1500 mA (from No Signal to Maximum Output)

TRANSMITTER

Frequency Tolerance	\pm 0.0005%
Maximum Output Power	4 Watts (maximum allowed by FCC)
Spurious Emission	-65 dB or better
Transmit Battery Drain	1270 mA to 1870 mA (from No Modulation to 80% Modulation Limit)
Modulation Frequency Response (1 kHz, 0 dB Reference):	
Lower, at 450 Hz	-3 dB
Upper, at 2.5 kHz	-3 dB
Modulation Type and Capacity	A3 and 85%
Microphone Sensitivity	5 mV for 50% Modulation

GENERAL

Channels	40
Frequency Range	26.965 MHz to 27.405 MHz
Frequency Control	Phase-Locked Loop Synthesizer
Operating Temperature Range	-22°F to 122°F
Power Requirements	13.8V DC (12-16 volts DC, Negative Ground)
Input Power	7.5 W (Reference Value)
Antenna	50 Ohm (Coaxial Connector)
Microphone	Condenser Type

Internal Speaker 16 Ohm, 5 Watts
Dimensions (HWD) $1\frac{9}{16} \times 5\frac{9}{16} \times 7\frac{5}{16}$ inches
(40 mm x 142 mm x 185 mm)
Weight 2 lbs (930 g)

Specifications are typical; individual units might vary. Specifications are subject to change and improvement without notice.

ACCESSORIES

Depending on how and where you plan to use your CB radio, the following accessories can be used with your CB radio for enhanced functionality and power. Visit your local RadioShack store or go to www.radioshack.com to browse for a variety of CB accessories.

CB Antenna

SWR Meter

8-ohm External Speaker

12V DC Power Supply

Base Station Antenna

Coaxial Antenna Cable and Connectors

Antenna Connectors

2-Amp Glass Fuse (for fuse replacement)

Limited Ninety-Day Warranty

This product is warranted by RadioShack against manufacturing defects in material and workmanship under normal use for ninety (90) days from the date of purchase from RadioShack company-owned stores and authorized RadioShack franchisees and dealers. EXCEPT AS PROVIDED HEREIN, RadioShack MAKES NO EXPRESS WARRANTIES AND ANY IMPLIED WARRANTIES, INCLUDING THOSE OF MERCHANTABILITY AND FITNESS FOR A PARTICULAR PURPOSE, ARE LIMITED IN DURATION TO THE DURATION OF THE WRITTEN LIMITED WARRANTIES CONTAINED HEREIN. EXCEPT AS PROVIDED HEREIN, RadioShack SHALL HAVE NO LIABILITY OR RESPONSIBILITY TO CUSTOMER OR ANY OTHER PERSON OR ENTITY WITH RESPECT TO ANY LIABILITY, LOSS OR DAMAGE CAUSED DIRECTLY OR INDIRECTLY BY USE OR PERFORMANCE OF THE PRODUCT OR ARISING OUT OF ANY BREACH OF THIS WARRANTY, INCLUDING, BUT NOT LIMITED TO, ANY DAMAGES RESULTING FROM INCONVENIENCE, LOSS OF TIME, DATA, PROPERTY, REVENUE, OR PROFIT OR ANY INDIRECT, SPECIAL, INCIDENTAL, OR CONSEQUENTIAL DAMAGES, EVEN IF RadioShack HAS BEEN ADVISED OF THE POSSIBILITY OF SUCH DAMAGES.

Some states do not allow limitations on how long an implied warranty lasts or the exclusion or limitation of incidental or consequential damages, so the above limitations or exclusions may not apply to you.

In the event of a product defect during the warranty period, take the product and the RadioShack sales receipt as proof of purchase date to any RadioShack store. RadioShack will, at its option, unless otherwise provided by law: (a) correct the defect by product repair without charge for parts and labor; (b) replace the product with one of the same or similar design; or (c) refund the purchase price. All replaced parts and products, and products on which a refund is made, become the property of RadioShack. New or reconditioned parts and products may be used in the performance of warranty service. Repaired or replaced parts and products are warranted for the remainder of the original warranty period. You will be charged for repair or replacement of the product made after the expiration of the warranty period.

This warranty does not cover: (a) damage or failure caused by or attributable to acts of God, abuse, accident, misuse, improper or abnormal usage, failure to follow instructions, improper installation or maintenance, alteration, lightning or other incidence of excess voltage or current; (b) any repairs other than those provided by a RadioShack Authorized Service Facility; (c) consumables such as fuses or batteries; (d) cosmetic damage; (e) transportation, shipping or insurance costs; or (f) costs of product removal, installation, set-up service adjustment or reinstallation.

This warranty gives you specific legal rights, and you may also have other rights which vary from state to state.

RadioShack Customer Relations, 200 Taylor Street, 6th Floor, Fort Worth, TX 76102

12/99